



[Home](#)
[About Us](#)
[Products](#)
[Accessories](#)
[Customization](#)
[Buy Now!](#)
[Contact Us](#)
[PRODUCTS](#)

Products: S-Series 152



MODEL	LENGTH	WIDTH	HEIGHT	DRAWINGS	
				(.pdf)	(.dwg)
152	5.630"	3.250"	2.010"		
Click to view circuit board diagram (350/332, 450/432)					

FEATURES

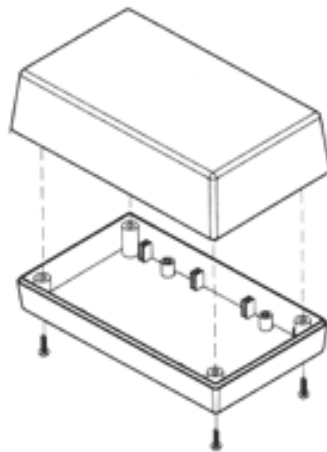

- Two-piece standard design
- Circuit board mounting bosses
- Wall mount option (select models)
- Assembly with four screws
- Customization available
 - two insert areas/I-Plates ([top and bottom](#))
 - [machining](#)
 - [pad printing](#)

COLORS



Black



Almond



Gray

[Custom Colors Also Available](#)

[RETURN TO TOP](#)

ACCESSORIES (Click an accessory for compatible models and part numbers)

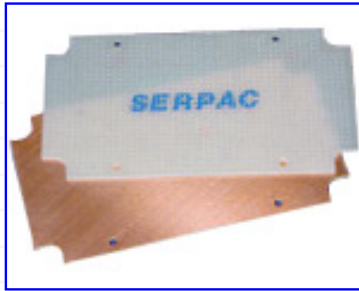

Grid and Clad Prototyping Boards
(P/N 350/332, 450/432)

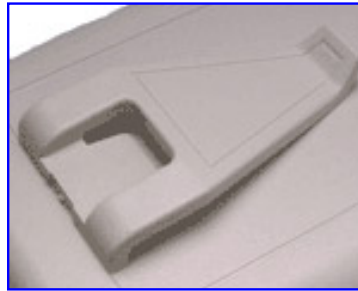

Pocket Clip



Key Holder



Non-Skid Feet (P/N 50)

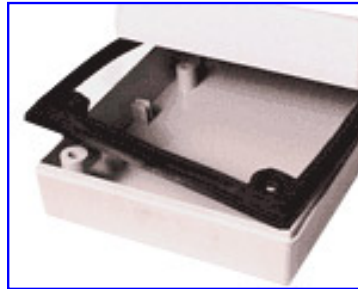

Perimeter Seal (P/N PS-15)

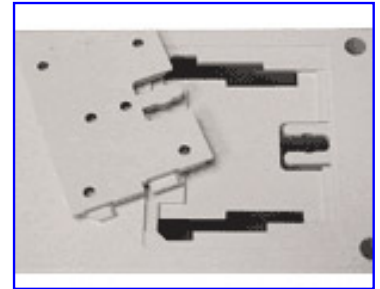

Wall Mount

[RETURN TO TOP](#)

[Home](#) | [About SERPAC](#) | [Products](#) | [Accessories](#) | [Customizations](#) | [Distributors](#) | [Buy Now!](#) | [Contact Us](#)

PRODUCTS: [A-Series](#) | [C-Series](#) | [CA-Series](#) | [CH-Series](#) | [G-Series](#) | [H-Series](#) | [M-Series](#) | [R-Series](#) | [S-Series](#) | [SL-Series](#)

© 2004, SERPAC Electronic Enclosures. All Rights Reserved